

ROTATING OVEN / 1 DOOR

MILANO

RIF. COD. **FRIB**



M.A.M. s.r.l.
Via C. Angiolieri, 28-34
41123 Modena (Italy)
Tel. +39 059 330219
mam@mamforni.it
P. IVA 02170610360



www.mamforni.it

TECHNICAL CHARACTERISTICS

MODEL	UM	Ø 95
Height of the cooktop	cm	120
Door width	cm	54/68
Power consumption	Kw Volt	0,36 220
Total weight (standard finish)	Kg	1300
Pizza capacity	n.	5 - 6
Under-floor burner		O

Minimum flue dimensions: Ø 20 cm.

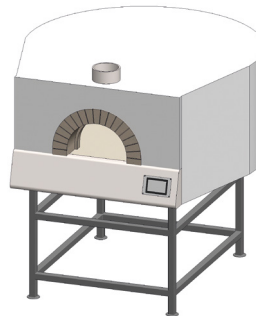

DIMENSIONS	UM	Ø 95
A - DEPTH	cm	163
B - WIDTH	cm	152
C - HEIGHT	cm	190
D	cm	120
E	cm	105
F	cm	94
G	cm	105
Headband foot overhang	cm	17

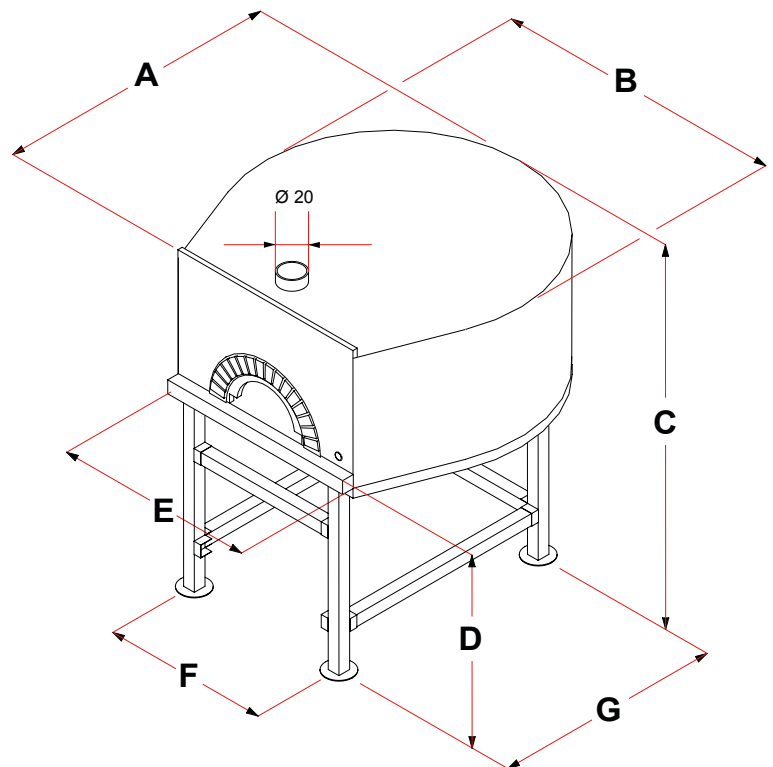

WOOD DATA

Minimum distance from the combustible material	Contact
CO emission produced during combustion	0,48 %
Combustion fume temperature	305° C
Thermic outlet used (heating)	11,5 Kw
Energy efficiency	66,7 %
Fuel typer	Wood logs
CO** (mg/Nm ³)	5848
Powders** (mg/Nm ³)	248

MADE IN ITALY **CE** 05

Prefabricated wood-fired oven
1935/2004 -2001/95/CE

** values corrected to 10% of O₂

