

FORNO STATICO / 1 BOCCA TORINO

RIF. COD. **TN**



M.A.M. s.r.l.
Via C. Angiolieri, 28-34
41123 Modena (Italy)
Tel. +39 059 330219
mam@mamforni.it
P. IVA 02170610360



www.mamforni.it

CARATTERISTICHE TECNICHE

MODELLO	UM	Ø 120
Altezza piano di cottura	cm	120
Larghezza bocca	cm	54/68
Peso totale (finitura standard)	Kg	1100
Capienza pizze	n.	7 - 8

Dimensioni minime canna fumaria: Ø 20 cm.

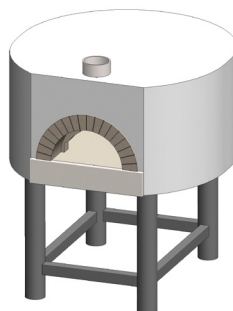

DIMENSIONI	UM	Ø 120
A - PROFONDITÀ	cm	180
B - LARGHEZZA	cm	160
C - ALTEZZA	cm	200
D	cm	120
F	cm	109
G	cm	105

DATI TERMICI GAS	UM	Ø 120
Potenza Termica	Kw	34
Consumo GPL	Kg/h	2,681
Consumo Metano	m³/h	3,598
Temperatura Fumi	°C	200
Tiraggio	Pa	12
Allacciamento Gas	in	1/2
Tipo di Costruzione		A1-B11BS
Consumo corrente Elettrica	Kw	100

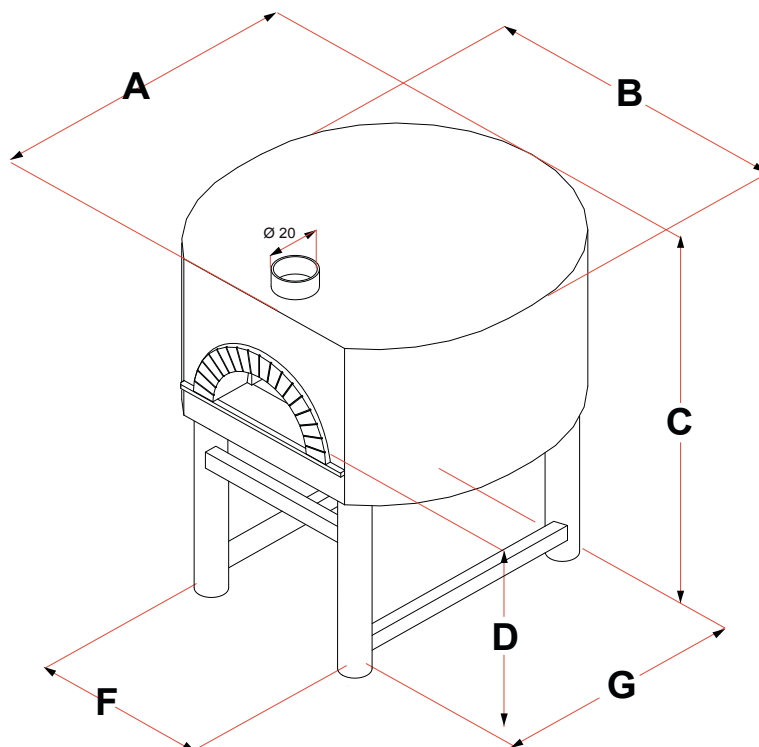

CE

IMQ Tested

