

FORNO STATICO / 1 BOCCA

NAPOLI

RIF. COD. N



M.A.M. s.r.l.
Via C. Angiolieri, 28-34
41123 Modena (Italy)
Tel. +39 059 330219
mam@mamforni.it
P. IVA 02170610360

COMBINATO

www.mamforni.it

CARATTERISTICHE TECNICHE

MODELLO	UM	Ø 120
Altezza piano di cottura	cm	105/120
Larghezza bocca	cm	54/68
Peso totale (finitura standard)	Kg	1100
Capienza pizze	n.	7 - 8

Dimensioni minime canna fumaria: Ø 20 cm.

DIMENSIONI	UM	Ø 120
A - PROFONDITÀ	cm	180
B - LARGHEZZA	cm	160
C - ALTEZZA	cm	200 - 220
D	cm	105 - 120
F	cm	109
G	cm	105

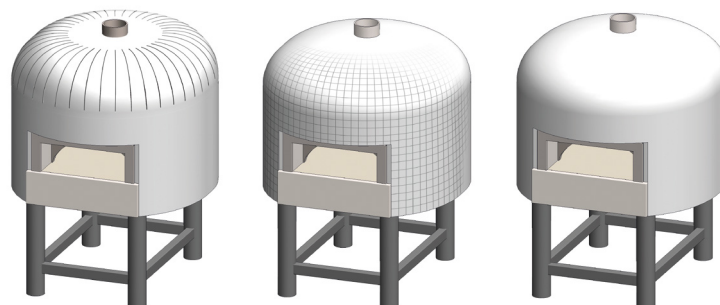

SPICCHIO

MOSAICO

BASE

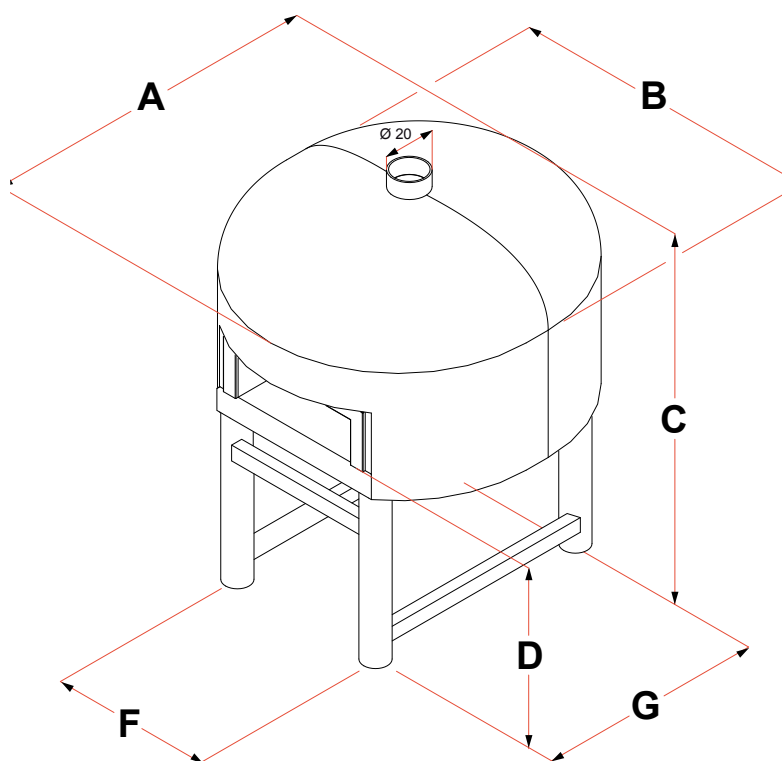

DATI TERMICI GAS	UM	Ø 120
Potenza Termica	Kw	34
Consumo GPL	Kg/h	2,681
Consumo Metano	m³/h	3,598
Temperatura Fumi	°C	200
Tiraggio	Pa	12
Allacciamento Gas	in	1/2
Tipo di Costruzione		A1-B11BS
Consumo corrente Elettrica	Kw	100

DATI LEGNA	
Distanza Minima del materiale combustibile	Contatto
Emissione di CO prodotta in combustione	0,48 %
Temperatura del fumo di combustione	305° C
Uscita termica utile (riscaldamento)	11,5 Kw
Efficienza dell'energia	66,7 %
Tipo di combustibile	Legno in pezzi
CO (mg/Nm³)	5848
Polveri (mg/Nm³)	248

MADE IN ITALY 05

Forno a legna prefabbricato
1935/2004 - 2001/95/CE

